

SPECIFICATION SHEET FOR H₂S SENSOR TYPE H2S/C-200

PERFORMANCE CHARACTERISTICS

Nominal Range	0 – 200 ppm
Maximum Overload	500 ppm
Expected Operation Life	2 years in air
Output Signal	370 ± 80 nA/ppm
Resolution	0,25 ppm
Temperature Range	- 20 °C to 45 °C
Pressure Range	Atmospheric ± 10%
Pressure Coefficient	No data
T ₉₀ Response Time	< 60 sec
Relative Humidity Range	15 % to 90 % R.H. non-condensing
Typical Baseline Range (pure air, 20°C)	< 2 ppm
Maximum Zero Shift (+20°C to +40°C)	2 ppm
Expected Long Term Output Drift	< 2% signal loss/month
Recommended Load Resistor	10 Ohm
Bias Voltage	Not recommended
Repeatability	< 2 % of signal
Output Linearity	Linear

PHYSICAL CHARACTERISTICS

Weight	~ 13 g
Position Sensitivity	None
Storage Life	Six months in container
Recommended Storage Temperature	5 °C – 20 °C
Warranty Period	12 months from date of dispatch

Compact-Size Outline Dimensions

BOTTOM VIEW

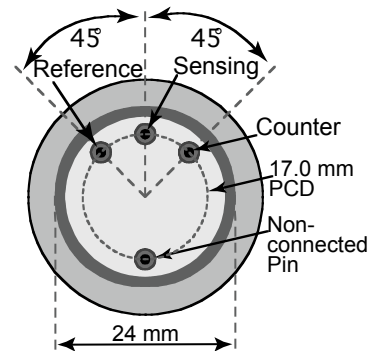

SIDE VIEW

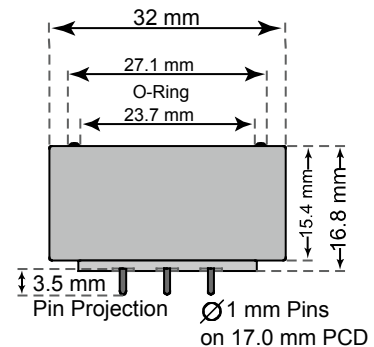

CROSS-SENSITIVITY DATA

Interfering Gas	Concentration	Reading
CO	100 ppm	< 2 ppm
SO ₂	100 ppm	~ 20 ppm
NO	35 ppm	< 2 ppm
NO ₂	5 ppm	~ - 1 ppm
H ₂		< 1 ppm

Performance data conditions:
20 °C, 50% RH and 1013 mbar

APPLICATIONS

Continuous Air Quality Monitoring
Safety and Environmental Control

SPECIFICATION SHEET FOR H₂S SENSOR TYPE H2S/C-200

TEMPERATURE DEPENDENCE

The output of an electrochemical sensor varies with temperature. The graphs below show the variation in output with temperature for this type of sensor. The results are shown in the graphs as a mean for a batch of sensors, along with confidence intervals corresponding to ± 3 times the standard deviation. The sensitivity dependence is expressed as a percentage of the signal at 20 °C. The shift in baseline is shown in ppm referenced to 20 °C.

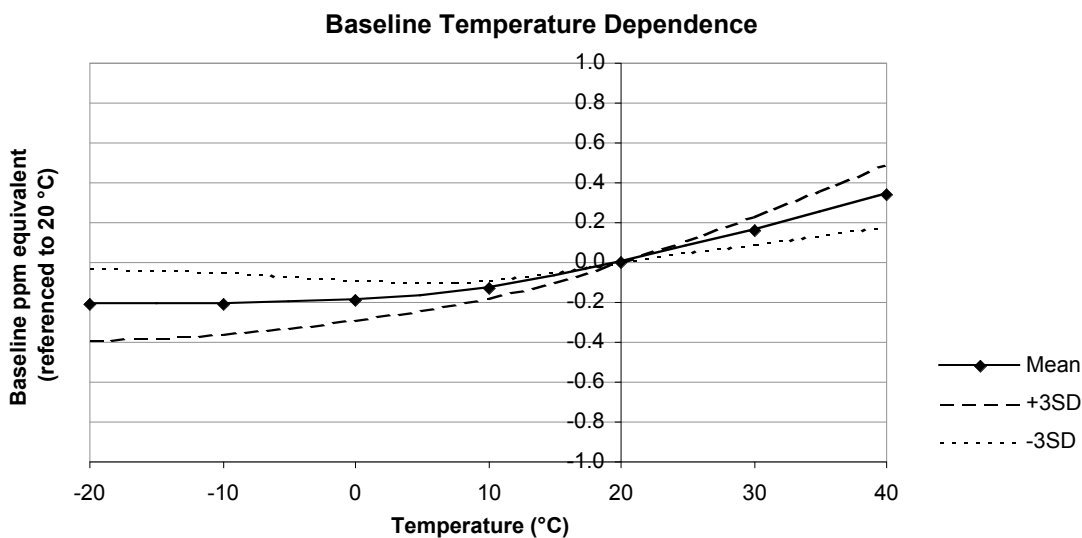
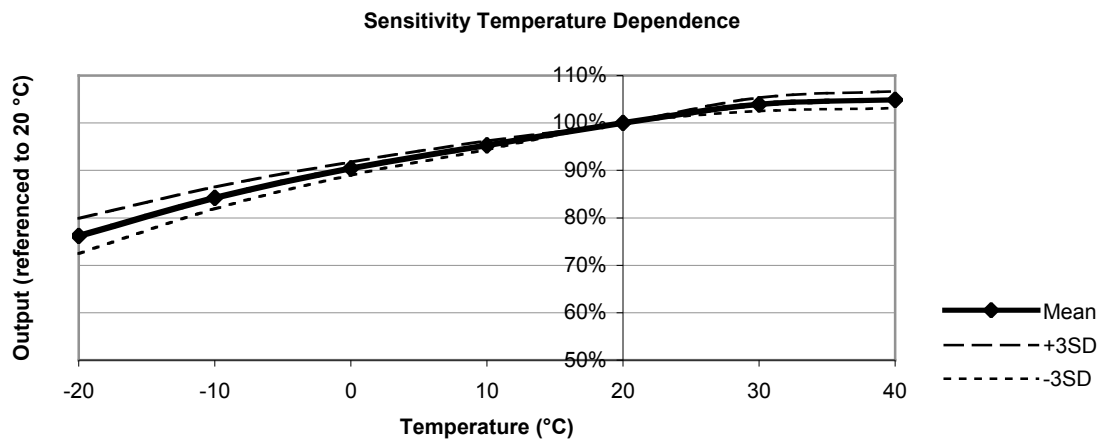

The data contained in this document is for guidance only. Membrapor AG accepts no liability for any consequential losses, injury or damage resulting from the use of this document or the information contained within it. The data is given for guidance only. Customers should test under their own conditions, to ensure that the sensors are suitable for their own requirements.